

# Fingerprint Time Attendance System

Self-Service Report, desktop mount for optional

## Ronald Jack T8



## Features

- 2.8 inch TFT color screen and friendly UI
- Self-Service Report, it's easy to check employee attendance report
- Voice prompt for fingerprint acceptance and rejection
- Can download SSR report from T8 by USB flash disk
- Support many kinds of Schedule bell
- Support USB Host and TCP/IP
- Desktop mount is optional



Workcode



Card



T9 input



SSR report



TCP/IP

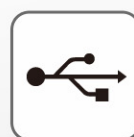

USB host



Auto status



Schedule bell

# Working Application

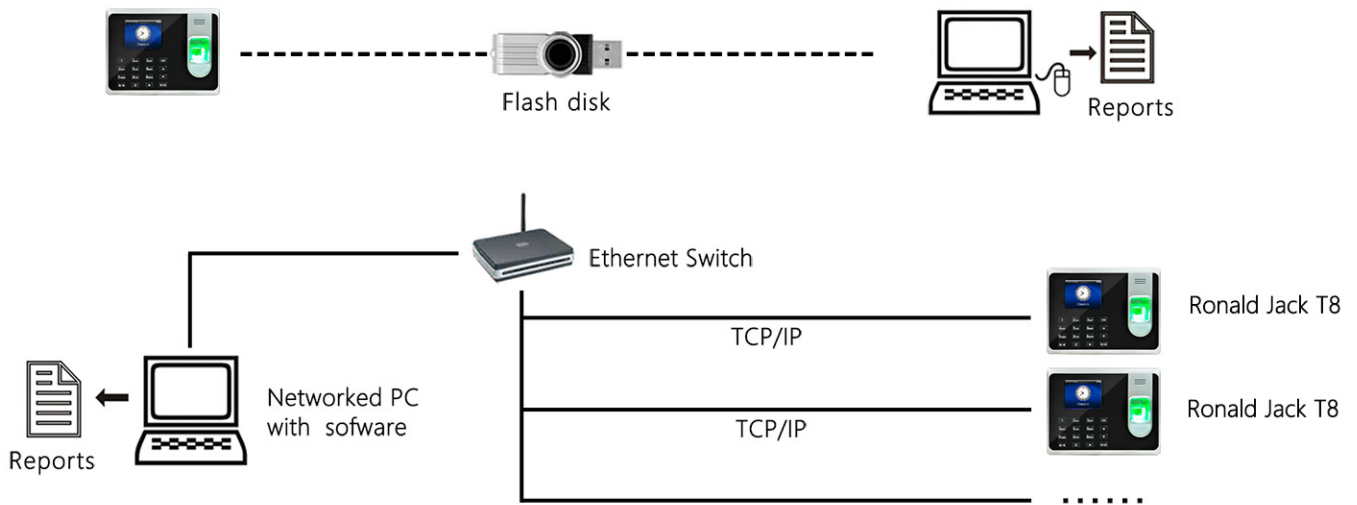

# Specification

Model	Ronald Jack T8
LCD Display	2.8 inch TFT color screen
Speaker	Voice prompt(language can be selected)
Capacity	Fingerprint: 3,000    Users: 3,000    Card: 3,000    Transaction: 100,000
Verification	Verification speed (1:1) ≤ 0.5S    Identification speed (1:1) ≤ 1S
Identification	FRR ≤ 0.01%    FAR ≤ 0.0001%
Communications	TCP/IP, USB Host
Power Supply	110/220 VAC-5VDC/1A
Language	English, Spanish, Arabic (other languages can be customized)
Environment	Operation temperature: 0°C-45°C    Operation humidity: 20%-80%
Package data	Machine size: 185(L)*140(W)*30(H)mm    Unit packing: 300*210*75cm Real weight: 0.75kg    Volume weight: 1.2kg
Function support	ID Card reader, Automatic Status, 9 PIN User ID, T9 Input, ADMS, Work code, DST
Optional	SSR report (1,000 Users, 3,000 Fingerprint)

# Package List

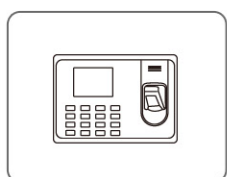

Device

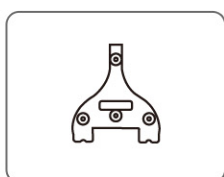

Mounted plate

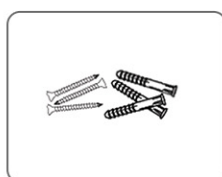

Screws

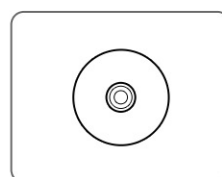

Software CD

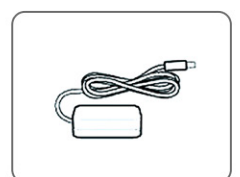

Power adapter